

J-20595-4

in Center Bonded Mounts - Safetied Tube Form Series

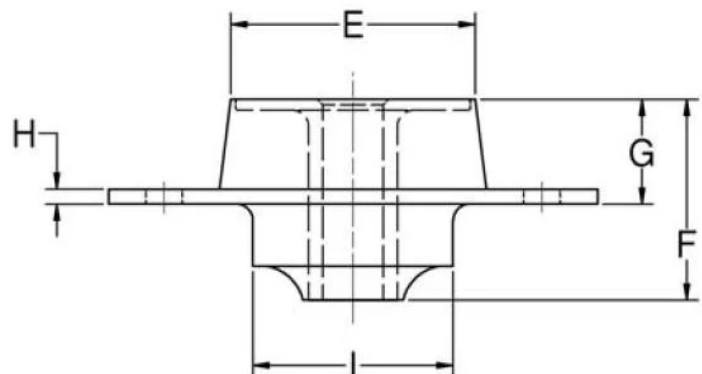
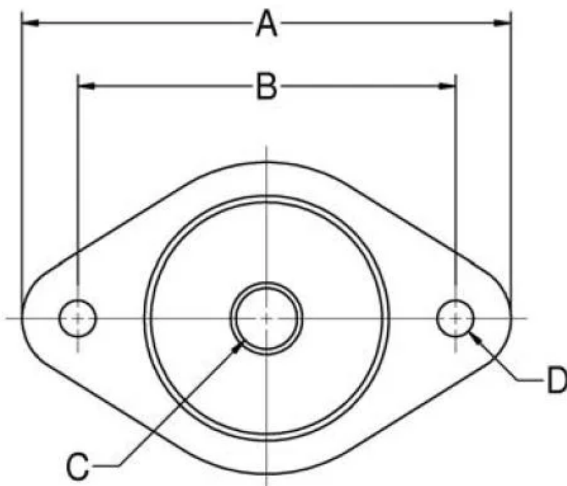

Center Bonded Mounts isolate vibration, control shock and reduce noise due to structure borne vibrations.

Available in a full range of rated load capacities and able to withstand shock loads of 10 g's, these mounts effectively protect equipment and improve operator comfort. They are ideal for automotive, marine, railroad and industrial markets.

Center Bonded Mounts provide flexible suspension systems for mobile, transport-mounted or portable equipment. Typical applications include engines, cabs, fuel tanks, pumps, air conditioning units, compressors and industrial machinery.

Non-Stock Item

- Easy installation because of one-piece design.
- Low-cost installation.
- Long service life.
- Consistent performance because of permanently bonded design.
- Shock protection in all directions provided by cushioned snubbing, no metal-to-metal bottoming.
- Standard sizes available from stock.
- Space-saving size.
- Captive installation after overload failure when recommended bolt, washer and nut are used.
- Accommodate English and Metric bolts.

Center Bonded Mounts isolate vibration, control shock and reduce noise due to structure borne vibrations.

Available in a full range of rated load capacities and able to withstand shock loads of 10 g's, these mounts effectively protect equipment and improve operator comfort. They are ideal for automotive, marine, railroad and industrial markets.

Center Bonded Mounts provide flexible suspension systems for mobile, transport-mounted or portable equipment. Typical applications include engines, cabs, fuel tanks, pumps, air conditioning units, compressors and industrial machinery.

Specifications

A (IN)	5.25
B (IN)	4.25
C (IN)	0.687
D (IN)	0.406
E (IN)	2.75
F (IN)	2.25
F (MM)	57.2
ELASTOMER	Natural Rubber

INSIDE DIAMETER (IN)	0.64
G (IN)	1.18
G (MM)	30
I (IN)	2.25
I (MM)	57.2
COLOR CODE	
MAX AXIAL LOAD RATING (LBS)	840
MAX AXIAL LOAD RATING (N)	3736
RECOMMENDED BOLT SIZE (IN)	5/8
MAX. RADIAL STATIC LOAD RATING (LBS)	560
MAX. RADIAL STATIC LOAD RATING (N)	2490
THICKNESS (IN)	0.125
THICKNESS (MM)	3.2
MAX. AXIAL STATIC LOAD RATING (LBS)	840
MAX. AXIAL STATIC LOAD RATING (N)	3736
PRODUCT TYPE	Mounts
MANUFACTURER	Lord Corporation
SERIES	Safetied Tube Form
OUTSIDE DIAMETER (IN)	2.25
OUTSIDE DIAMETER (MM)	57.2
SD (IN)	2.62
SD (MM)	66.5
T (IN)	0.69

NOM. AXIAL STATIC LOAD RATING (LBS)	560
NOM. AXIAL STATIC LOAD RATING (N)	2490
NOM. RADIAL STATIC LOAD RATING (LBS)	280
NOM. RADIAL STATIC LOAD RATING (N)	1245
AXIAL STATIC DEFLECTION AT NOMINAL LOAD (IN)	0.1
AXIAL STATIC DEFLECTION AT NOMINAL LOAD (MM)	2.5