

VFM-1565-3

in Center Bonded Mounts - Safetied Tube Form Series

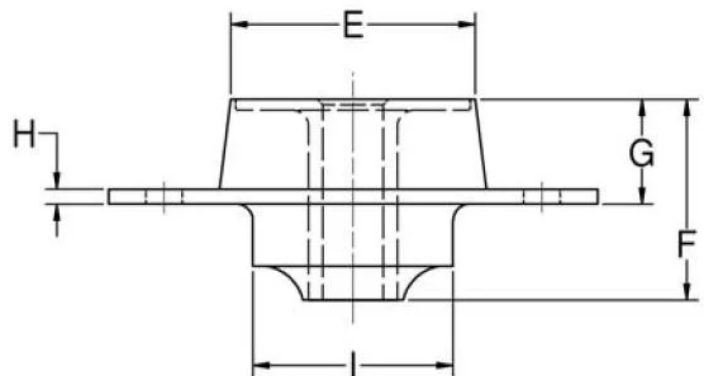
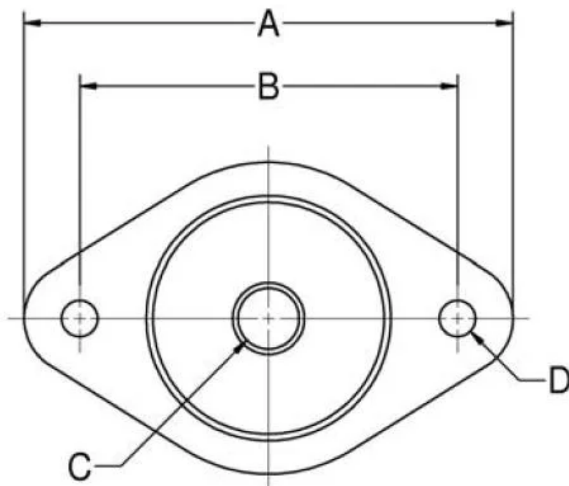

Center Bonded Mounts isolate vibration, control shock and reduce noise due to structure borne vibrations.

Available in a full range of rated load capacities and able to withstand shock loads of 10 g's, these mounts effectively protect equipment and improve operator comfort. They are ideal for automotive, marine, railroad and industrial markets.

units, compressors and industrial machinery.

Specifications

A (IN)	4.75
B (IN)	3.75
C (IN)	0.53
D (IN)	0.406
E (IN)	2
F (IN)	2
F (MM)	50
ELASTOMER	Neoprene
H (IN)	
H (MM)	
INSIDE DIAMETER (IN)	
G (IN)	1.03
G (MM)	25
I (IN)	
I (MM)	
COLOR CODE	
MAX AXIAL LOAD RATING (LBS)	450
MAX AXIAL LOAD RATING (N)	
RECOMMENDED BOLT SIZE (IN)	0.5
MAX. RADIAL STATIC LOAD RATING (LBS)	300
MAX. RADIAL STATIC LOAD RATING (N)	

THICKNESS (MM)	
MAX. AXIAL STATIC LOAD RATING (LBS)	450
MAX. AXIAL STATIC LOAD RATING (N)	
PRODUCT TYPE	Gen Set Mount
MANUFACTURER	RPM Mechanical
SERIES	
OUTSIDE DIAMETER (IN)	
OUTSIDE DIAMETER (MM)	
SD (IN)	
SD (MM)	
T (IN)	
T (MM)	
NOM. AXIAL STATIC LOAD RATING (LBS)	450
NOM. AXIAL STATIC LOAD RATING (N)	
NOM. RADIAL STATIC LOAD RATING (LBS)	300
NOM. RADIAL STATIC LOAD RATING (N)	
AXIAL STATIC DEFLECTION AT NOMINAL LOAD (IN)	0.13
AXIAL STATIC DEFLECTION AT NOMINAL LOAD (MM)	