

VMB-1075H

in Sandwich Mounts (Metric Thread) Type 2

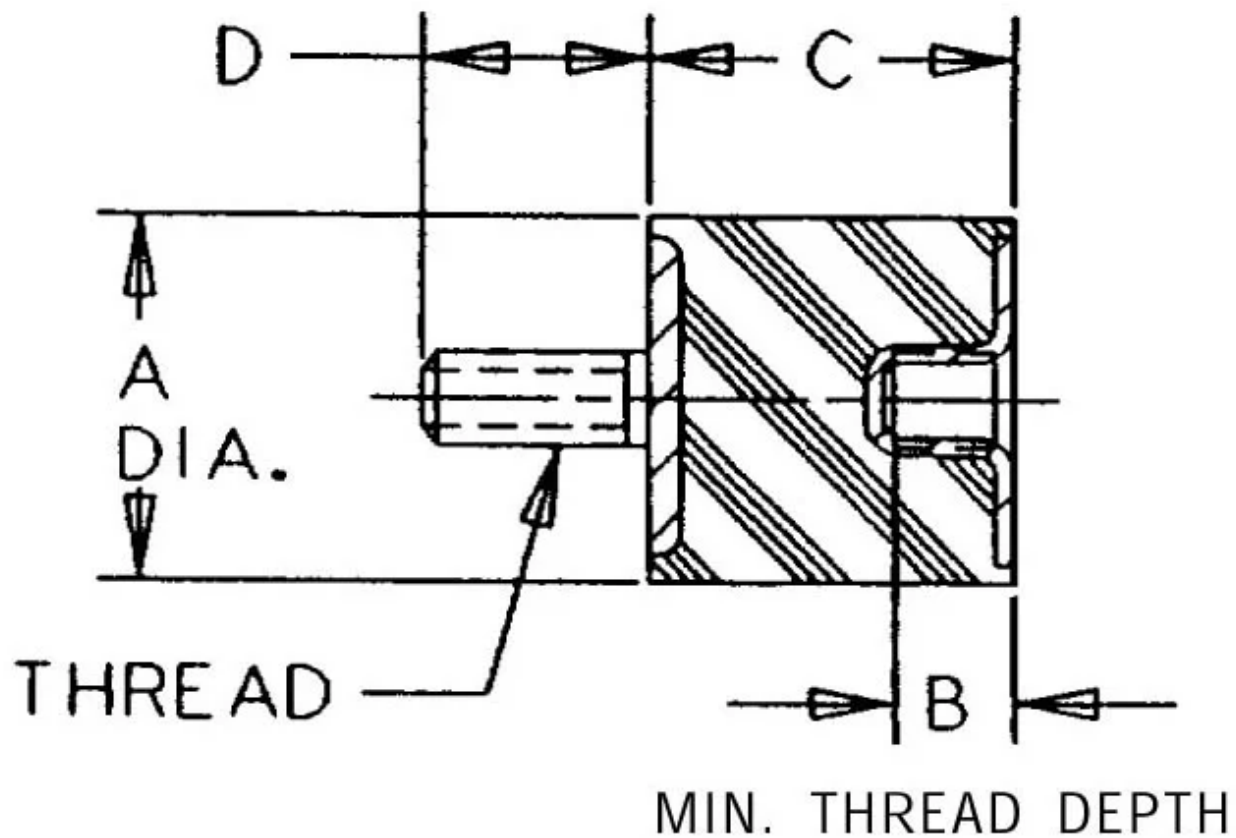

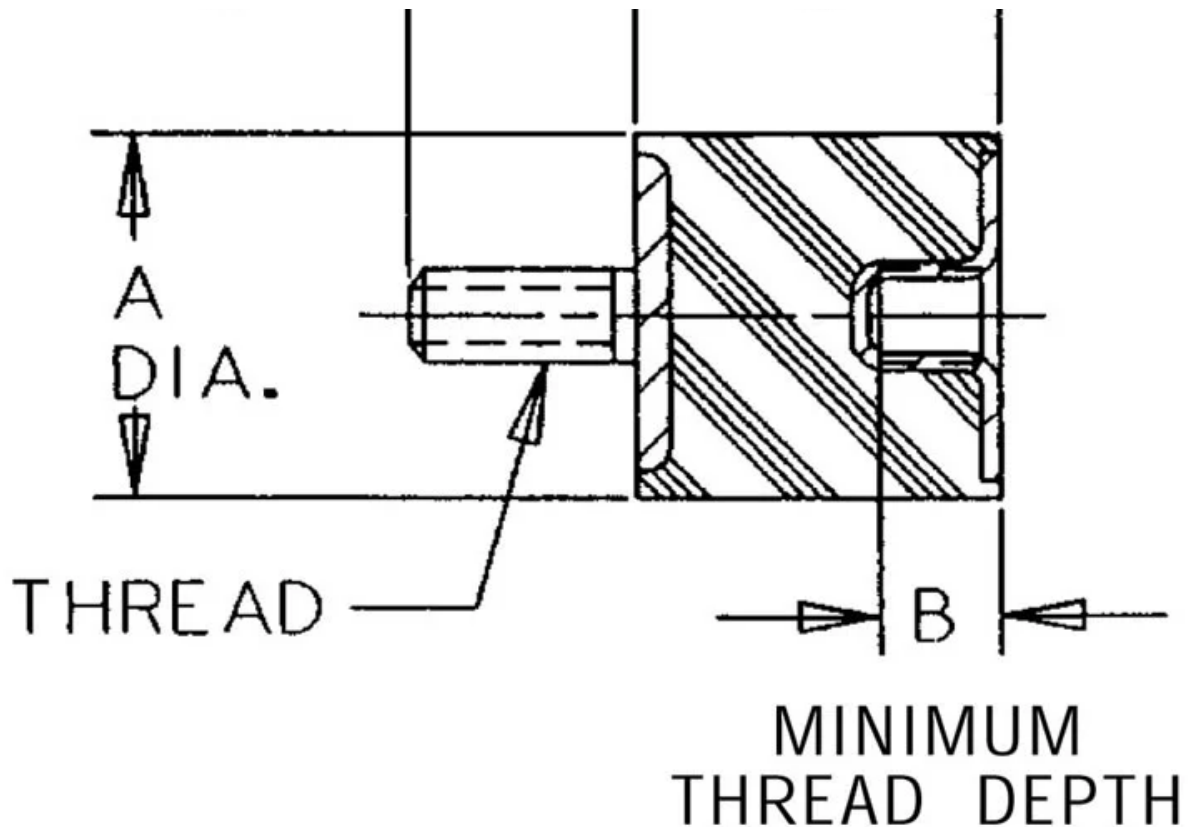

- Economical.
- Compact and lightweight.
- Easy to install.
- Maintenance-free.
- Three size groups: small, medium and large.
- Unitized construction.

Rubber Flex Sandwich Mounts are designed to protect equipment and machinery against damaging vibration. This family of mounts has excellent capacity for energy control. Constructed with high-strength bonds and specially compounded elastomers, these mounts provide high load-carrying capacity and assure long life.

The simple design and unitized construction provide low-cost mounting systems which are compact, lightweight, easy to install and maintenance-free.

These mounts are available in three size groups to suit a variety of applications. Rubber Flex Sandwich Mounts are available in metric and standard (UNC) threads.

Typical applications for Rubber Flex Sandwich Mounts include medical equipment, business machines, motorcycles, heating, ventilating and air conditioning equipment, light motors, appliances, shipping containers, feeders, compactors and vibratory rollers.

COMPRESSION STATIC LOAD (LBS)	705
COMPRESSION STATIC LOAD (N)	3140
COMPRESSION - SPRING RATE KC (LBS/IN)	59
COMPRESSION - SPRING RATE KC (N/MM)	333
SHEAR STATIC LOAD (LBS)	235
SHEAR STATIC LOAD (N)	1047
SHEAR - SPRING RATE KS (LBS/IN)	12
SHEAR - SPRING RATE KS (N/MM)	71
A (IN)	4
B (IN)	0.63
C (IN)	3
D (IN)	1.77
THREAD SIZE	M16
DUROMETER	43
ELASTOMER	Natural Rubber
THREAD TYPE	Metric
PRODUCT TYPE	Mounts
MANUFACTURER	RPM Mechanical Inc
TYPE	2
GRADE PER SAE J429	4.6