

VMB-4035H10U

in Sandwich Mounts (UNC Thread) Type 2

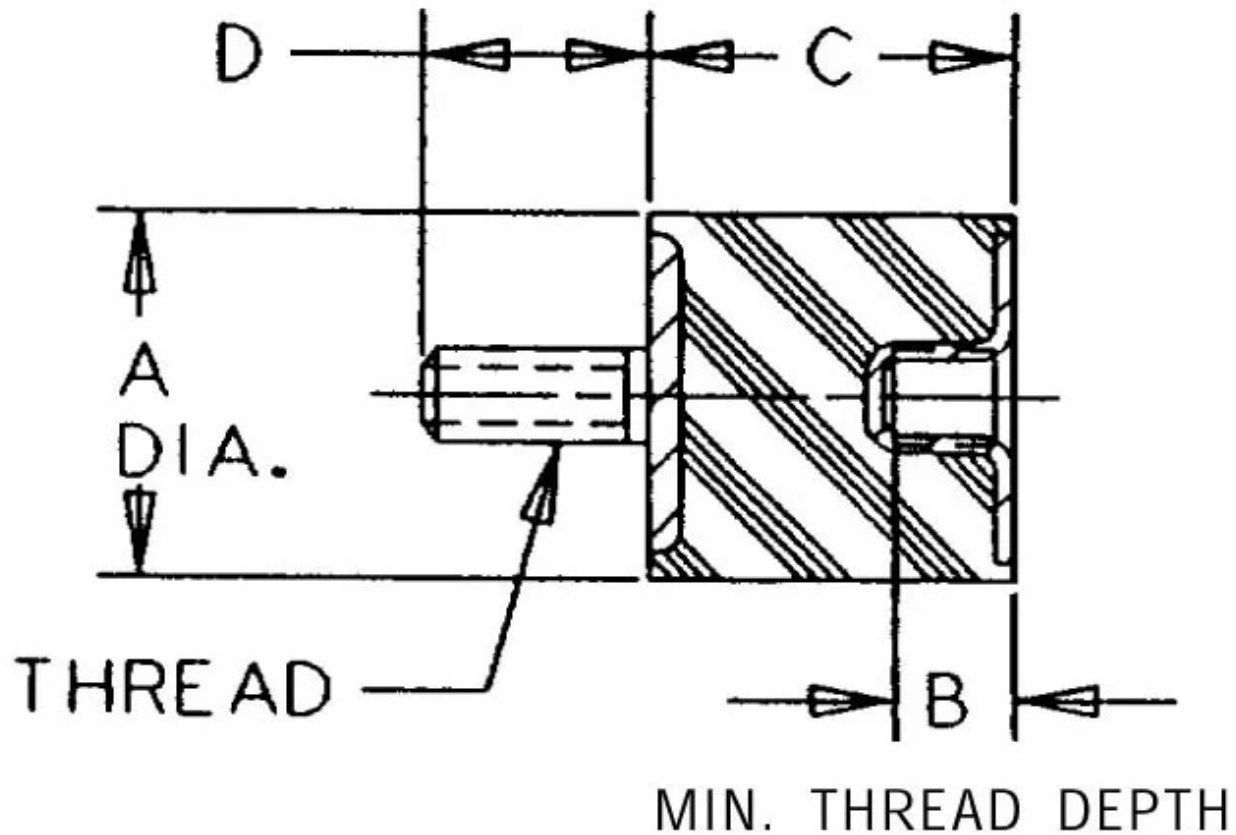

- Economical.
- Compact and lightweight.
- Easy to install.
- Maintenance-free.

Rubber Flex Bobbin Sandwich Mounts are designed to protect equipment and machinery against damaging vibration. This family of mounts has excellent capacity for energy control. Constructed with high-strength bonds and specially compounded elastomers, these mounts provide high load-carrying capacity and assure long life.

The simple design and unitized construction provide low-cost mounting systems which are compact, lightweight, easy to install and maintenance-free.

These mounts are available in three size groups to suit a variety of applications. Small Rubber Flex Bobbin Sandwich Mounts are available in metric and standard (UNC) threads.

Typical applications for Rubber Flex Bobbin Sandwich Mounts include business machines, medical equipment, motorcycles, heating, ventilating and air conditioning equipment, light motors, appliances, shipping containers, feeders, compactors and vibratory rollers.

Specifications

COMPRESSION STATIC LOAD (LBS)	107
COMPRESSION STATIC LOAD (N)	476
COMPRESSION - SPRING RATE KC (LBS/IN)	20
COMPRESSION - SPRING RATE KC (N/MM)	111
SHEAR STATIC LOAD (LBS)	36
SHEAR STATIC LOAD (N)	159
SHEAR - SPRING RATE KS (LBS/IN)	4
SHEAR - SPRING RATE KS (N/MM)	25
A (IN)	1.57
B (IN)	0.38
C (IN)	1.38
D (IN)	1
THREAD SIZE	3/8-16 UNC
DUROMETER	43

PRODUCT TYPE	Mounts
MANUFACTURER	RPM Mechanical Inc
TYPE	2
GRADE PER SAE J429	1