

VMK-4017

in Vibration Foot

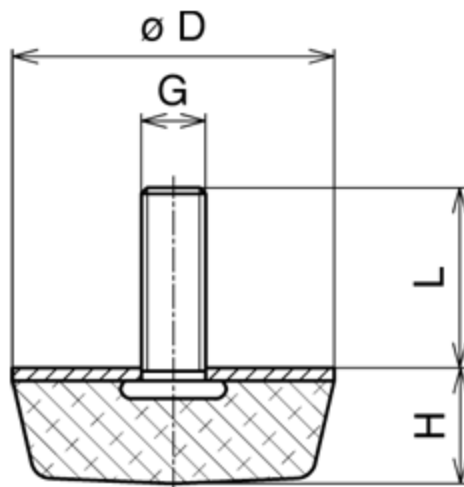

RPM Mechanical's vibration isolator foot mount is specifically designed to isolate noise and vibration in a simple to use and easy to install package. A very economical way to isolate vibration to help protect sensitive equipment, it's simple design provides excellent isolation while reducing assembling time.

Available in a variety of sizes. Contact our sales staff if you do not see the size you require, this product is also available in other materials on request.

Specifications

D (IN)	
--------	--

DURUMETER	57
ELASTOMER	Natural Rubber
H (IN)	0.67
H (MM)	
L (IN)	0.91
L (MM)	
THREAD TYPE	Metric
HEIGHT (IN)	0.67
LENGTH (IN)	0.91
LENGTH (MM)	
PRODUCT TYPE	
MANUFACTURER	RPM Mechanical Inc
DEPTH (IN)	1.57
DEPTH (MM)	