



CANADA
2290 Industrial Street
Burlington, Ontario L7P 1A1

USA
4392 Broadway
Depew, NY 14043, USA

888.842.5668
905.335.5523
rpmrubberparts.com

106PHL-4

in Multiplane Mounts (Holder)

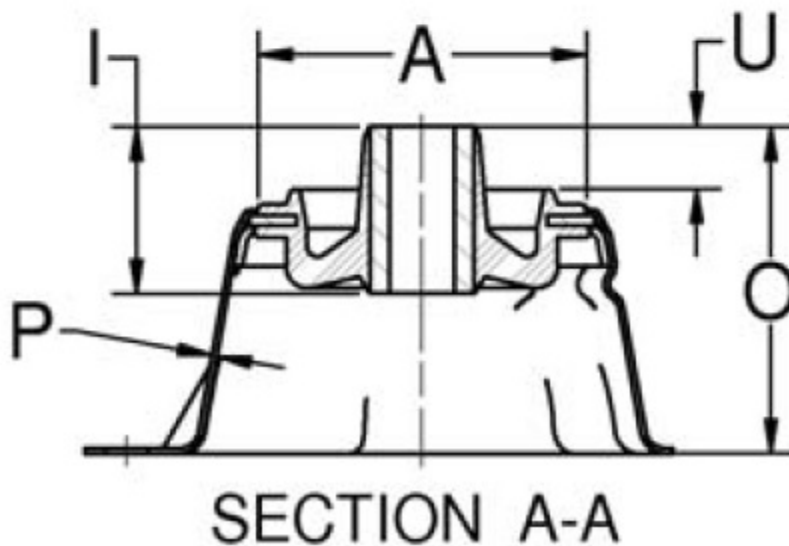
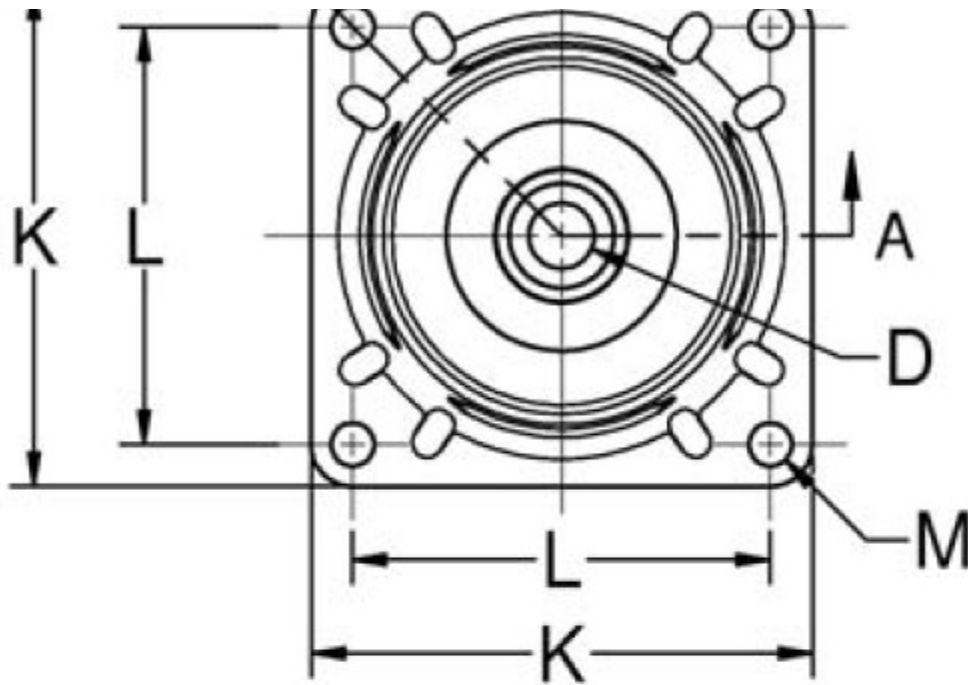

Lord Platform Mounts provide effective isolation against vibration. The contour of the flexing element was developed to provide uniform stress distribution. This, plus high strength bonding and the use of specially compounded elastomers, provides maximum service life.

These versatile mounts are available in three types, each type featuring square, diamond or holder configurations to suit a variety of design requirements. The three types, Platform Mounts, Heavy-Duty Platform Mounts and Multiplane Mounts, offer a range in load ratings from 0.5 to 600 pounds.

Snubbing washers provide an interlocking system of metal parts which act to prevent damage from overload or excessive shock impact.

Lord Platform Mounts are easy to install and provide space efficiency. Typical applications include electronic equipment, business machines, medical equipment and small pumps, engines and gen sets.

- Three types of mounts for different applications.

- Uniform stress distribution.
- Easy to install.

Specifications

A (IN)	1
B (IN)	1.25
C (IN)	1
D (IN)	0.166
E (IN)	0.141
F (IN)	0.032
F (MM)	0.8
L (IN)	
L (MM)	
MATERIAL	Aluminum
INSIDE DIAMETER (IN)	0.17
MAX. AXIAL RATED LOAD @ 1/16 IN (1.58 MM) DEFLECTION (LBS)	4
MAX. AXIAL RATED LOAD @ 1/16 IN (1.58 MM) DEFLECTION (N)	18
AXIAL STATIC SPRING RATE (LBS/IN)	21
AXIAL STATIC SPRING RATE (N/MM)	3.7
G (IN)	0.53
G (MM)	13.5
I (IN)	0.84
I (MM)	21.3

O (MM)	40.1
Q (IN)	1.414
Q (MM)	35.9
MAX AXIAL LOAD RATING (LBS)	4
MAX AXIAL LOAD RATING (N)	18
THICKNESS (IN)	0.032
THICKNESS (MM)	0.8
K (IN)	1.69
K (MM)	42.9
PRODUCT TYPE	Mounts
MANUFACTURER	Lord Corporation
SERIES	106
ENCLOSURE SHAPE	Holder
M (IN)	0.141
M (MM)	3.6
P (IN)	0.025
P (MM)	0.6
R (IN)	0.62
R (MM)	15.7
S (IN)	1.66
S (MM)	42.2
U (IN)	0.38
U (MM)	9.7

RECOMMENDED STEEL WASHER	J-2049-1
--------------------------	----------